

WALL SYSTEMS

BESPOKE WALL CLADDINGS

2210 series

BESPOKE
WALL CLADDING

An open & no limitation design cladding. Can be custom manufactured to architect specifications. Ideal for complex geometric sizes & shapes. Effective impact protection for high traffic areas. High Acoustic performance. It's strong structure is suitable for integrated TV screens, sign boards & speakers. Progressive accessibility with easy access for services & maintenance without any access tool. Offered in a wide range of designs, sizes, colors & finishes.

FEATURES

MATERIAL

Aluminum Alloy as per EN AW 3000 or 5000 series.

Zinc Plated Galvanized Steel G90 grade.

THICKNESS

Aluminum or Galvanized Steel (mm):
1.0 to 3.0

+ Custom thickness are available upon request

SURFACE FINISH

Plain
Perforated

SIZE

WIDTH (mm): ≤ 2000

LENGTH (mm):
 ≤ 3000 (Aluminum)
 ≤ 2000 (Galvanized Steel)

+ Custom sizes are available upon request

COATING

Polyester Powder Coating:
(70 μ -80 μ)

+ High Performance Coatings like PESDF, PVDF and POLYAMIDE are available upon request.

INSULATION

Acoustic Black Fleece is non-flammable and meets the standard DIN 4102 / B1. Classification A1 according to EN 13501-1.

Rockwool slabs conforming to ASTM C612 and equivalent BS 3958-5 are provided for acoustic insulation.

COLOR / FINISH

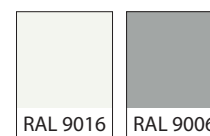
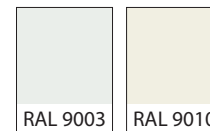

SPECIAL FINISHES

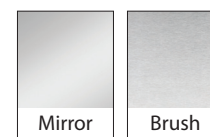
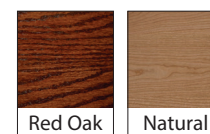

+ See www.rammatal.com for additional colors & special finishes available

+ Special finishes can be provided in lamination, sublimation or coil coating process.

PERFORATION PATTERNS

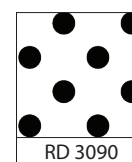
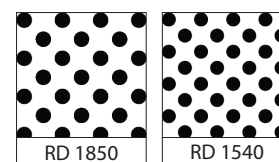

+ See www.rammatal.com for all other pattern options

DATA / PERFORMANCE



ACOUSTICS

Tested as per BS EN ISO 354: 2003 for sound absorption, noise reduction and sound attenuation.

NRC achieved with Acoustic Black fleece – NRC 0.75

NRC achieved with Acoustic Black Fleece and Rockwool Insulation- NRC 1.00



ANTI BACTERIAL COATING

Tested as per JIS Z 2801: 2000, which inhibits the growth of bacteria on the applied surface.



LIGHT REFLECTANCE (LR)

Achieved by the metal cladding is LR – 0.85-0.96 tested as per ASTM E 1477.



FIRE PERFORMANCE

Surface Spread of flame Class 1 tested as per BS 476: Part 7: 1997

“Non-Combustible” Material tested as per BS 476: Part4: 1970

Flame Spread and Smoke Development Index tested as per ASTM E84 (Class 1 or A)

RAM 2211 BESPOKE WALL PANEL

ISOMETRIC DETAIL

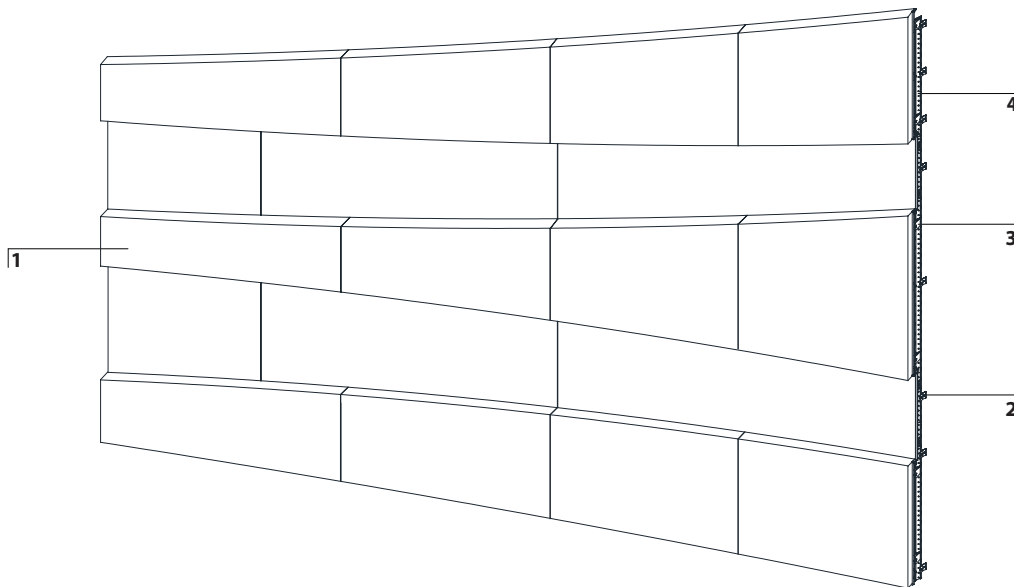

COMPONENTS

- 1 Panel
- 2 Omega Profile
- 3 Carrier Bracket
- 4 Adjustable C Channel
- 5 Backing Board •
- 6 Reinforcement Channel
- 7 Reinforcement Bracket
- 8 Bolts & Nuts
- 9 Blind Rivet
- 10 U Profile
- 11 Rockwool •

Custom sizes can be offered

SECTION DETAILS

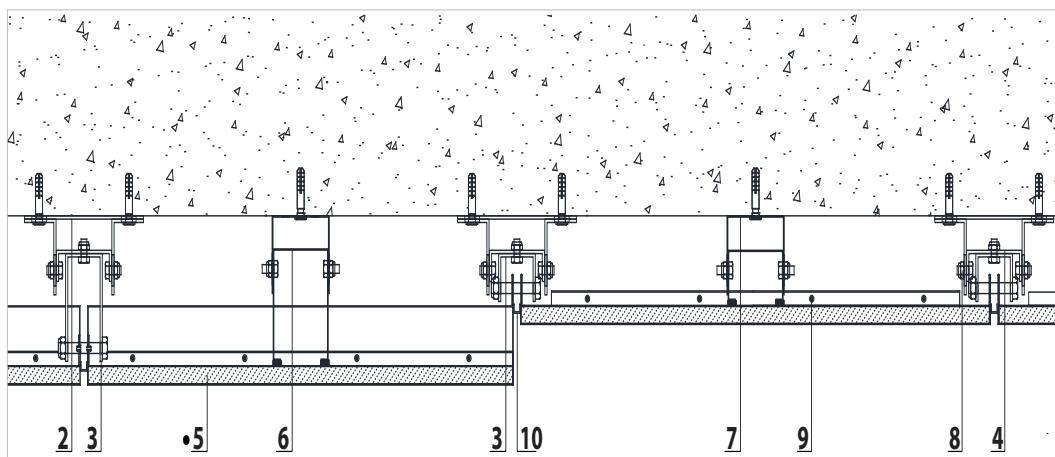

PANEL JOINTS DETAIL

