

CEILING SYSTEMS
BEAMGRID

520 series

THREADED/FLAT

This threaded/flush beam profile ceiling is an ideal solution for integrating ceiling with demountable partition, hanging & support for light (weight) signs & multimedia materials. Available with sound attenuation panels. Can be manufactured in single & double skin. The beam profile can be used to integrate light fittings, AC grills, and other MEP services. Offered as recess, flush, or reveled edge with the panel. Panels are laid on the beam profile, which can be produced in multiple sizes in order to avoid cutting the panels. Lifts upwards for access to ceiling void. Offered in a wide range of sizes, colors & finishes.

FEATURES

MATERIAL

Aluminum Alloy as per EN AW 3000 or 5000 series.

Zinc Plated Galvanized Steel G90 grade.

THICKNESS

PANELS (mm)

Aluminum or Galvanized Steel:
0.5 to 1.0

BEAMS (mm)

Galvanized Steel:
0.5 to 2.0

+ Custom thickness are available upon request

SURFACE FINISH

Plain
Perforated
Decorative Patterns

SIZE

TYPE

RAM 521: Threaded profile
RAM 522: Flat

BEAM WIDTH (mm): 100-300

DIMENSIONS (mm)

600x600/750x750/900x900/1000x1000/
1200x1200/1500x1500

+ Custom sizes are available upon request

COATING

Polyester Coating: ((5 μ (Back) + 20 μ (Face))

Polyester Powder Coating: (70 μ -80 μ)

+ High Performance Coatings like PESDF, PVDF and POLYAMIDE are available upon request.

INSULATION

Acoustic Black Fleece is non-flammable and meets the standard DIN 4102 / B1. Classification A1 according to EN 13501-1.

Rockwool slabs conforming to ASTM C612 and equivalent BS 3958-5 are provided for acoustic insulation.

COLORS

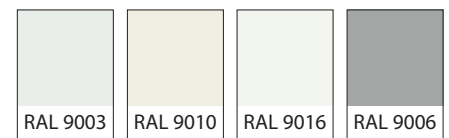

SPECIAL FINISHES



- + See www.rammetal.com for additional colors & special finishes available
- + Special finishes can be provided in lamination, sublimation or coil coating process.

PERFORATION PATTERNS

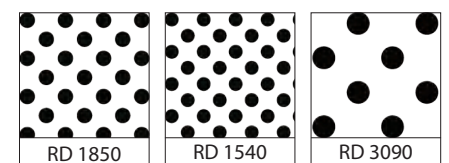

- + See www.rammetal.com for all available pattern options

DATA / PERFORMANCE



ACOUSTICS

Tested as per BS EN ISO 354: 2003 for sound absorption, noise reduction and sound attenuation.

NRC achieved with Acoustic Black fleece – NRC 0.75

NRC achieved with Acoustic Black Fleece and Rockwool Insulation – NRC 1.00

Tested as per ASTM E1414-11a for Airborne Sound Attenuation as per ISO 10848-2.

CAC can achieved up to – 48 dB

Perforated & Sound Attenuation cover



ANTI BACTERIAL COATING

Tested as per JIS Z 2801: 2000, which inhibits the growth of bacteria on the applied surface.



LIGHT REFLECTANCE (LR)

Achieved by the metal ceiling is LR – 0.85-0.96 tested as per ASTM E 1477.



FIRE PERFORMANCE

Surface Spread of flame Class 1 tested as per BS 476: Part 7: 1997

“Non-Combustible” Material tested as per BS 476: Part4: 1970

Flame Spread and Smoke Development Index tested as per ASTM E84 (Class 1 or A)

RAM 521 THREADED RAM 522 FLAT

ISOMETRIC DETAIL

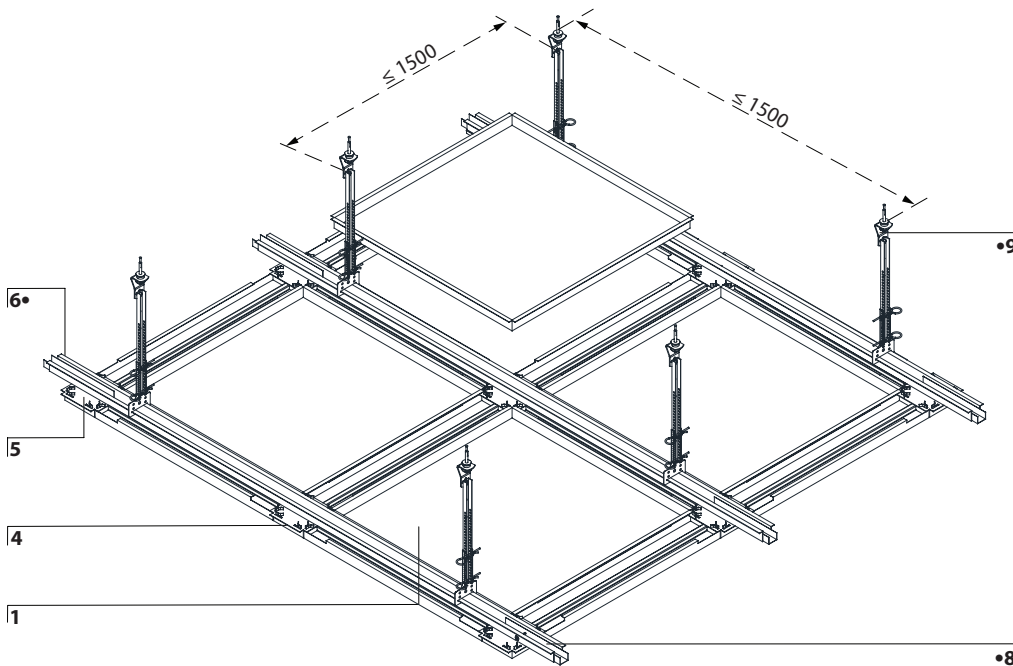

COMPONENTS

- 1 Panel
- 2 Beam Channel (Threaded)
- 3 Beam Channel (Flush)
- 4 Junction Box
- 5 Junction Plate
- 6 Beam Stabilizer •
- 7 Rigid Hanging System •
- 8 BS Splice •
- 9 Anti-Vibration Clip (RH) •
- 10 Wall Trim
- 11 Wall End Bracket •
- 12 Threaded Rod •



Luminous Panel •



Fire Resistant •

• Optional

Custom sizes can be offered

OPTIONAL HANGING SOLUTIONS

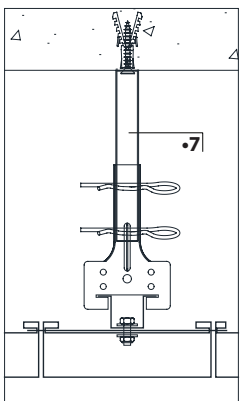

PANEL-BEAM JOINT DETAIL

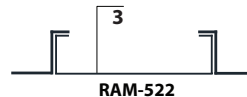
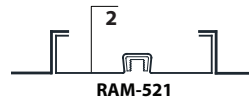

BEAM PARTITION DETAIL

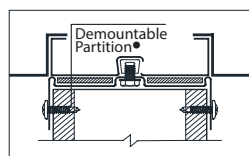

WALL END BRACKET DETAIL

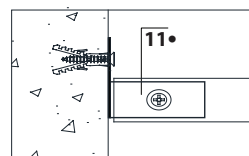

PERIMETER OPTIONS

